

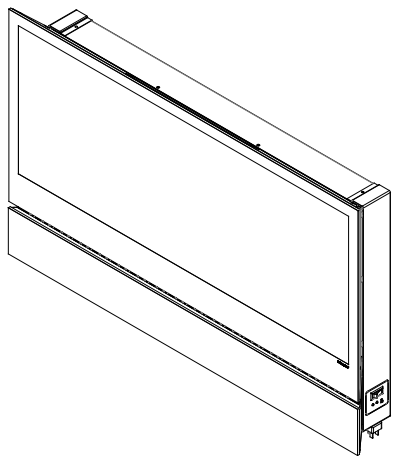

Better solutions through innovation



Owner's Manual

Model
DWF36









IMPORTANT SAFETY INFORMATION: Always read this manual first before attempting to install or use this fireplace. For your safety, always comply with all warnings and safety instructions contained in this manual to prevent personal injury or property damage.

To view the full line of Dimplex products, please visit
www.dimplex.com

7211490100R00



Table of Contents

| | |
|--|----|
|  Welcome & Congratulations | 3 |
|  IMPORTANT INSTRUCTIONS | 4 |
|  Fireplace Installation | 7 |
|  Operation | 11 |
|  Maintenance | 14 |
|  Warranty | 15 |
|  Replacement Parts | 17 |
|  Troubleshooting Guide | 18 |

Always use a qualified technician or service agency to repair this fireplace.

! NOTE: Procedures and techniques that are considered important enough to emphasize.

⚠ CAUTION: Procedures and techniques which, if not carefully followed, will result in damage to the equipment.

⚠ WARNING: Procedures and techniques which, if not carefully followed, will expose the user to the risk of fire, serious injury, or death.

Welcome & Congratulations

Thank you and congratulations for choosing to purchase an electric fireplace from Dimplex, the world leader in electric fireplaces.

Please carefully read and save these instructions.

⚠ CAUTION: Read all instructions and warnings carefully before starting installation. Failure to follow these instructions may result in a possible electric shock, fire hazard and will void the warranty.

Please record your model and serial numbers below for future reference: model and serial numbers can be found on the Model and Serial Number Label of your fireplace.

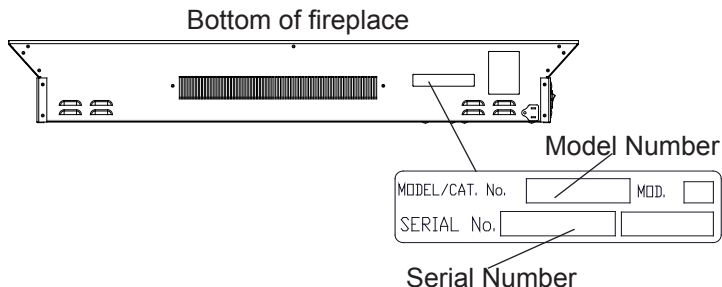

STOP NO NEED TO RETURN TO THE STORE

Questions with operation or assembly? Require Parts Information?
Product Under Manufacturer's Warranty?

Contact us at:  www.dimplex.com/customer_support
For Troubleshooting and Technical Support

OR  **Toll-Free 1-888-DIMPLEX (1-888-346-7539)**
Monday to Friday 8:00 a.m. to 4:30 p.m. EST
Please have your model number and product serial number ready. (See above)



IMPORTANT INSTRUCTIONS

When using electrical appliances, basic precautions should always be followed to reduce the risk of fire, electric shock and injury to person, including the following:

- ① Read all instructions before using this fireplace.
- ② The heater is hot when in use. To avoid burns, do not let bare skin touch hot surfaces. The trim around the heater outlet becomes hot during heater operation. Keep combustible materials, such as furniture, pillows, bedding, papers, clothes, and curtains at least 3 feet (0.9 m) from the front of the unit.
- ③ Extreme caution is necessary when any heater is used by or near children or invalids and whenever the unit is left operating and unattended.
- ④ Always unplug the fireplace when not in use.
- ⑤ Do not operate with a damaged cord or plug, or if the heater has malfunctioned, or if the fireplace has been dropped or damaged in any manner. Return heater to authorized service facility for examination, electrical or mechanical adjustment, or repair.
- ⑥ Do not use outdoors.
- ⑦ This fireplace is not intended for use in bathrooms, laundry areas and similar indoor locations. Never locate heater where it may fall into a bathtub or other water container.
- ⑧ Do not run the cord under carpeting. Do not cover cord with throw rugs, runners, or the like. Arrange cord away from traffic area and where it will not be tripped over. Make certain cord is placed away from the firebox, mantel or other furniture so they cannot be placed on it.
- ⑨ To disconnect the unit, turn the controls off, then remove the plug from the outlet.
- ⑩ Do not insert or allow foreign objects to enter any ventilation or exhaust opening as this may cause an electric shock or fire, or damage to the heater.
- ⑪ To prevent a possible fire, do not block air intake or exhaust in any manner. Do not use on soft surfaces, like a bed, where openings may become blocked.
- ⑫ All electrical heaters have hot and arcing or sparking parts inside. Do not use in areas where gasoline, paint, or flammable liquids are used or stored or where the unit will be exposed to flammable vapors.



IMPORTANT INSTRUCTIONS

- ⑬ Do not modify the fireplace. Use it only as described in this manual. Any other use not recommended by the manufacturer may cause fire, electric shock or injury to persons.
- ⑭ To reduce the risk of electric shock, this appliance must be grounded. Avoid the use of an extension cord. Extension cords may overheat and cause a risk of fire. If you must use an extension cord, the cord must be No. 14 AWG minimum size and rated no less than 1875 Watts.
- ⑮ Do not burn wood or other materials in the wall mount fireplace.
- ⑯ Do not strike the glass front.
- ⑰ Always use a certified electrician should new circuits or outlets be required.
- ⑱ Always use properly grounded, fused and polarized outlets.
- ⑲ Disconnect all power supply before performing any cleaning, maintenance or relocation of the unit.
- ⑳ If the power supply cord is damaged, it must be replaced by the manufacturer, its service agent or similarly qualified persons in order to avoid a hazard.
- ㉑ The heater must not be located immediately below a socket-outlet.



CAUTION
RISK OF ELECTRIC SHOCK
DO NOT OPEN
NO USER SERVICEABLE PARTS INSIDE



SAVE THESE INSTRUCTIONS



IMPORTANT INSTRUCTIONS

⚠ WARNING: Remote control contains small batteries. Keep away from children. If swallowed, seek medical attention immediately.

⚠ WARNING: Do not install battery backwards, charge, put in fire or mix with used or other battery types - may explode or leak causing injury.

! NOTE: Changes or modifications not expressly approved by the party responsible for compliance could void user's authority to operate the equipment.

! NOTE: This equipment has been tested and found to comply with the limits for Class B digital device, pursuant to part 15 of the FCC Rules. These limits are designed to provide reasonable protection against harmful interference in a residential installation. This equipment generates, uses and can radiate radio frequency energy and, if not installed and used in accordance with the instructions, may cause harmful interference to radio or television reception, which can be determined by turning the equipment off and on, the user is encouraged to try to correct the interference by one or more of the following measures:

- Increase the separation between the equipment and the receiver.
- Connect the equipment into an outlet on a circuit different from that to which the receiver is connected.
- Consult the dealer or an experienced radio/TV technician for help.

Operation is subject to the following two conditions: (1) this device may not cause interference and (2) this device must accept any interference, including interference that may cause undesired operation of the device.



Quick Reference Guide

- ① The electrical information regarding your electric fireplace can be found on the rating label located on the bottom of the unit, see above.
- ② Before installation, please record your fireplace's serial number above for future reference. The serial number can be found on the Model and Serial Number Label of your fireplace.
- ③ If you have any technical questions or concerns regarding the operation of your electric fireplace, or require service contact customer service.



Fireplace Installation

Site Selection

! NOTE: A 15 Amp, 120 Volt circuit is required. A dedicated circuit is preferred but not essential in all cases. A dedicated circuit will be required if, after installation, the circuit breaker trips or the fuse blows on a regular basis when the heater is operating. Additional appliances on the same circuit may exceed the current rating of the circuit breaker.

⚠ CAUTION: When the heater is in use, this product draws a high, continuous electrical current. Not all electric

receptacles are designed to work with high, continuous currents. If you plan on using this unit in an old, worn, or loose receptacle, or are unsure if the receptacle is suitable, please have it inspected by a qualified electrician prior to using this product.

⚠ WARNING: Ensure the power cord is not installed so that it is pinched or against a sharp edge and ensure that the power cord is stored or secured to avoid tripping or snagging to reduce the risk of fire, electric shock or injury to persons.

Fireplace Installation

Construction and electrical outlet wiring must comply with local building codes and other applicable regulations to reduce the risk of fire, electric shock and injury to persons.

Do not attempt to wire your own new outlets or circuits. To reduce the risk of fire, electric shock or injury to persons, always use a licensed electrician.

⚠ WARNING: The supplied mounting bracket is designed for use with Dimplex wall mounted fireplaces only. Improper use, or use for purposes other than intended, may cause damage or injury.

Installation

⚠ WARNING: Failure to install the fireplace as instructed below may result in damage to the equipment and or may expose the user to the risk of fire, serious injury, illness or death.

⚠ WARNING: The fireplace requires the wall mounting bracket screws to be installed into a minimum of two wall studs (Figure 1).

Figure 1

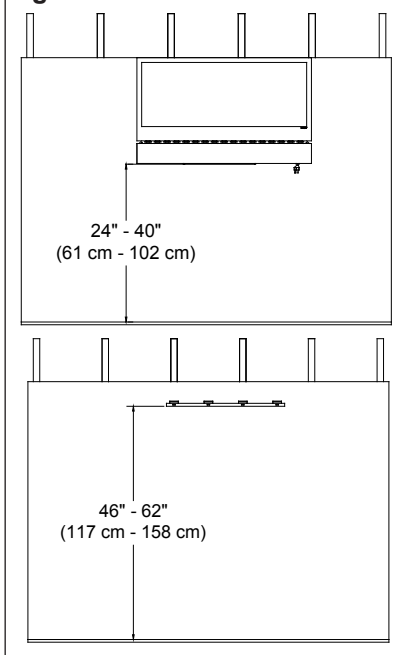
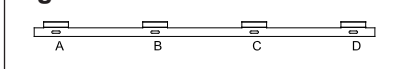

Figure 2



Tools Required

- #2 Phillips screwdriver
- Pencil
- Slot screwdriver
- Bubble level (supplied)
- Drill, and drill bits as required

Approximate time: 30 minutes
for installation

Fireplace Installation

1. Select an appropriate location to mount the unit on a wall, above an electrical outlet. The bottom of the unit must be a minimum of 24 inches (61 cm) above the floor (mounting bracket 46 inches (117 cm) above the floor). Access to the electrical outlet must be maintained. Ensure the installation meets the national and state/provincial electrical codes.

! NOTE: It is recommended that the bottom of the unit not be mounted higher than 40 inches (102 cm) from the ground (mounting bracket no higher than 62 inches (158 cm)).

⚠ WARNING: Ensure the front of the installed unit will be at least three (3) feet (0.9 m) from combustible materials, such as furniture, pillows, bedding, papers, clothes, and curtains.

2. The wall-mounting bracket must be mounted to at least two (2) wall studs. Studs should be accessed through two (2) wall-bracket holes in one of the following combinations: A&C, B&D, or A&D (Figure 2).

Figure 3

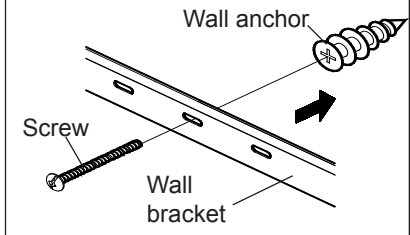

! NOTE: Wall anchors must be installed in the appropriate wall locations to fasten the wall bracket through the remaining holes (Figure 3). For example, if you plan to secure the bracket to studs through holes A&D, install anchors centered on holes B and C.

3. Hold the wall-mounting bracket on the wall and mark the location of ONE (1) of the mounting holes.
4. Place the bubble level onto the top of the wall-mounting bracket.
5. Adjust the wall-mounting bracket so the bubble on the level is centered between the two black lines.
6. Mark three (3) other mounting screw locations, on the wall, ensuring that the wall bracket stays level.

Fireplace Installation

7. Install the supplied wall anchors on the marked locations by placing a #2 Phillips screwdriver into the recess of the anchor.
8. Press the anchor into the wall in the desired marked position while turning the anchor clockwise until it is flush with the wall.
9. Insert the wall anchor screws through the wall bracket and thread into the wall anchors. Tighten the screw (Figure 3).
10. Install the remaining screws through the bracket and into the wall studs as required.

! NOTE: At least two of the mounting screws must be installed into a wall stud.

11. Remove the (2) screws securing the firebox enclosure cover. (Figure 4)
12. With the firebox tilted forward, carefully pour and evenly distribute the supplied glass rock media on the front tray of the firebox (Figure 5).
13. Once complete, use the enclosed rake to make sure the glass rock media is level in the firebox. (Figure 6)

Figure 4

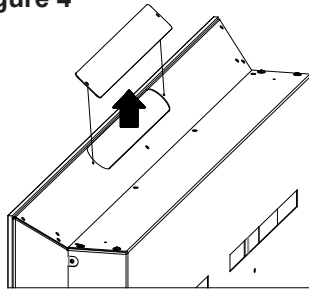
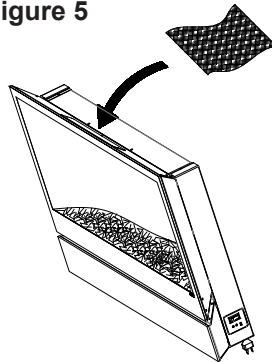

Figure 5



⚠ WARNING: When raking the glass rocks be careful that the rake does not scratch the mirror.

14. Replace the enclosure cover.
15. Mount the unit on the wall as shown (Figure 7).

Fireplace Installation

Figure 6

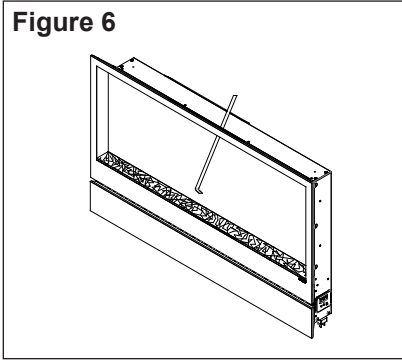
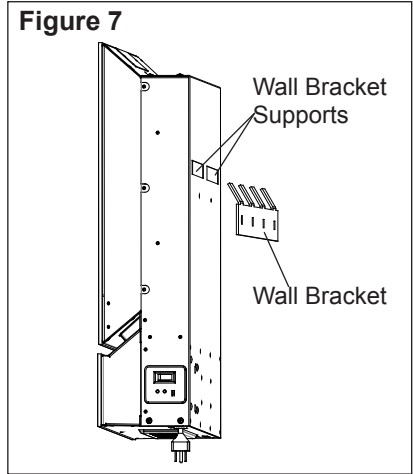
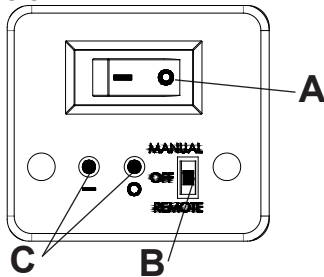

Figure 7



Operation

Figure 8



The manual controls for the electric fireplace are located on the right end of the unit (Figure 8).

A. Main On/Off Switch

The Main On/Off Switch supplies power to all fireplace functions.

When the switch is in the “ I ” position, the unit is on. When in the “ O ” position, the fireplace is off.

B. Three Position Switch

The Three Position Switch changes the mode the fireplace operates in and has three (3) positions: “ **MANUAL** ”; “ **OFF** ”; and “ **REMOTE** ”.

When in “ **REMOTE** ” mode, the fireplace's three levels of operation are controlled by the ON and OFF buttons of the remote control transmitter.

In “ **OFF** ” mode, power to all

Operation

functions is cut off.

In “**MANUAL**” mode, the fireplace's three levels of operation are controlled by the Manual Control Buttons.

C. Manual Control Buttons

The Manual Control Buttons operate the fireplace levels sequentially (from off): flames only; to flames and low heat; to flames and high heat.

The level is increased every time the “**I**” button is pressed, and the fireplace can be turned off at any point by pressing the “**O**” button.

Resetting The Temperature Cutoff Switch

Should the heater overheat, an automatic switch will turn the heater off and it will not come back on without being reset. The temperature cutoff switch can be reset by unplugging the unit, waiting five (5) minutes and plugging the unit back in.

⚠ CAUTION: If you need to continuously reset the heater, unplug the unit and call Dimplex customer service at 1-888-DIMPLEX (1-888-346-7539).

Figure 9

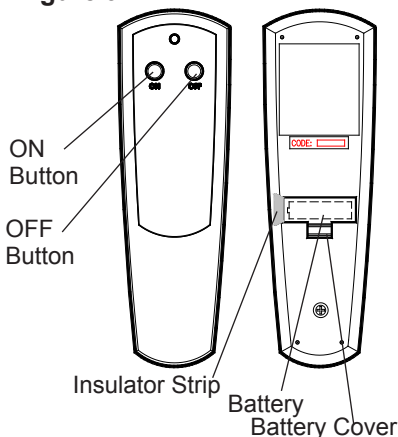

Remote Control

The fireplace is supplied with a radio frequency remote control. This remote control has a range of approximately 50 feet (15.25 m), it does not have to be pointed at the fireplace and can pass through most obstacles (including walls). It is supplied with one of hundreds of independent frequencies to prevent interference with other units.

! NOTE: Before attempting any operation with the remote, pull the plastic insulator strip out from between the remote casing and battery cover (Figure 9).

Operation

Remote Control Initialization/ Reprogramming

If the hand held transmitter or receiver board has been replaced, follow these steps to initialize the transmitter and receiver:

1. Ensure that power is supplied through the main service panel.
2. Turn Main On/Off Switch to On (Figure 8A).
3. Move the Three Position Switch to the “ REMOTE ” position (Figure 8B).
4. Press and hold the Manual Control Button marked “ 1 ” for five (5) seconds. After five (5) seconds, there is a 10 second window to press any button on the remote control.
5. Press any button on the remote control transmitter within that 10 seconds.

This will synchronize the remote control transmitter and receiver.

Remote Control Usage

The remote control operates the fireplace levels sequentially (from off): flames only; to flames and low heat; to flames and high heat. The level is increased every time the ON button is pressed on the

remote control transmitter and the fireplace can be turned off at any point by pressing the OFF button.

Battery Replacement

To replace the battery:

1. Slide battery cover open on the hand held transmitter (Figure 7).
2. Install one (1) 12-Volt (A23) battery in the battery holder.
3. Close the battery cover.



Battery must be recycled or disposed of properly. Check with your Local Authority or Retailer for recycling advice in your area.



Maintenance

⚠ WARNING: Disconnect power before attempting any maintenance or cleaning to reduce the risk of fire, electric shock or damage to persons.

Mirror Cleaning

The mirror is cleaned in the factory during the assembly operation. During shipment, installation, handling, etc., the mirror may collect dust particles; these can be removed by dusting lightly with a clean dry cloth.

To remove fingerprints or other marks, the mirror can be cleaned with a damp cloth. The mirror should be completely dried with a lint free cloth to prevent water spots. To prevent scratching, do not use abrasive cleaners.

Fireplace Surface Cleaning

Use only a damp cloth to clean painted surfaces of the fireplace. Do not use abrasive cleaners.

Servicing

Except for installation and cleaning described in this manual, an authorized service representative should perform any other servicing.



Warranty

Products to which this limited warranty applies

This limited warranty applies to the following models of your newly purchased Dimplex electric fireplace **DWF36** and to newly purchased Dimplex fireplace surrounds (mantels) and trims. This limited warranty applies only to purchases made in any province of Canada except for Yukon Territory, Nunavut, or Northwest Territories or in any of the 50 States of the USA (and the District of Columbia) except for Hawaii and Alaska. This limited warranty applies to the original purchaser of the product only and is not transferable.

Products excluded from this limited warranty

Light bulbs are not covered by this limited warranty and are the sole responsibility of the owner/purchaser. Products purchased in Yukon Territory, Nunavut, Northwest Territories, Hawaii, or Alaska are not covered by this limited warranty. Products purchased in these States, provinces, or territories are sold AS IS without warranty or condition of any kind (including, without limitation, any implied warranties or conditions of merchantability or fitness for a particular purpose) and the entire risk of as to the quality and performance of the products is with the purchaser, and in the event of a defect the purchaser assumes the entire cost of all necessary servicing or repair.

What this limited warranty covers and for how long

Products, other than fireplace surrounds (mantels) and trims, covered by this limited warranty have been tested and inspected prior to shipment and, subject

to the provisions of this warranty, Dimplex warrants such products to be free from defects in material and workmanship for a period of 1 year from the date of the first purchase of such products.

Dimplex fireplace surrounds (mantels) and trims covered by this limited warranty have been tested and inspected prior to shipment and, subject to the provisions of this warranty, Dimplex warrants such products to be free from defects in material and workmanship for a period of 1 year from the date of first purchase of such products.

The limited 1 year warranty period for products other than fireplace surrounds (mantels) and trims and the limited 1 year warranty period for fireplace surrounds (mantels) and trims also applies to any implied warranties that may exist under applicable law. Some jurisdictions do not allow limitations on how long an implied warranty lasts, so the above limitation may not apply to the purchaser.

What this limited warranty does not cover

This limited warranty does not apply to products that have been repaired (except by Dimplex or its authorized service representatives) or otherwise altered. This limited warranty does further not apply to defects resulting from misuse, abuse, accident, neglect, incorrect installation, improper maintenance or handling, or operation with an incorrect power source.

What you must do to get service under this limited warranty

Defects must be brought to the attention of Dimplex Technical Service by contacting Dimplex at 1-888-DIMPLEX (1-888-346-7539), or 1367 Industrial Road,



Warranty

Cambridge Ontario, Canada N1R 7G8. Please have proof of purchase, catalogue/ model and serial numbers available when calling. Limited warranty service requires a proof of purchase of the product.

What Dimplex will do in the event of a defect?

In the event a product or part covered by this limited warranty is proven to be defective in material or workmanship during (i) the 1 year limited warranty period for products other than fireplace surrounds (mantels) and trims, and (ii) the 1 year limited warranty period for surrounds (mantels) and trims, you have the following rights:

- Dimplex will in its sole discretion either repair or replace such defective product or part without charge. If Dimplex is unable to repair or replace such product or part, or if repair or replacement is not commercially practicable or cannot be timely made, Dimplex may, in lieu of repair or replacement, choose to refund the purchase price for such product or part.
- Limited warranty service will be performed solely by dealers or service agents of Dimplex authorized to provide limited warranty services.
- Dimplex will not be responsible for, and the limited warranty services shall not include, any expense incurred for installation or removal of the product or part (or any replacement product or part) or any labour or transportation costs. Such costs shall be the purchaser's responsibility.

What Dimplex and its dealers and service agents are also not responsible for:

IN NO EVENT WILL DIMPLEX, OR ITS DIRECTORS, OFFICERS, OR AGENTS, BE LIABLE TO THE PURCHASER OR ANY THIRD PARTY, WHETHER IN CONTRACT, IN TORT, OR ON ANY OTHER BASIS, FOR ANY INDIRECT, SPECIAL, PUNITIVE, EXEMPLARY, CONSEQUENTIAL, OR INCIDENTAL LOSS, COST, OR DAMAGE ARISING OUT OF OR IN CONNECTION WITH THE SALE, MAINTENANCE, USE, OR INABILITY TO USE THE PRODUCT, EVEN IF DIMPLEX OR ITS DIRECTORS, OFFICERS, OR AGENTS HAVE BEEN ADVISED OF THE POSSIBILITY OF SUCH LOSSES, COSTS OR DAMAGES, OR IF SUCH LOSSES, COSTS, OR DAMAGES ARE FORESEEABLE. IN NO EVENT WILL DIMPLEX, OR ITS OFFICERS, DIRECTORS, OR AGENTS BE LIABLE FOR ANY DIRECT LOSSES, COSTS, OR DAMAGES THAT EXCEED THE PURCHASE PRICE OF THE PRODUCT.

SOME JURISDICTIONS DO NOT ALLOW THE EXCLUSION OR LIMITATION OF INCIDENTAL OR CONSEQUENTIAL DAMAGES, SO THE ABOVE LIMITATION OR EXCLUSION MAY NOT APPLY TO THE PURCHASER.

How State and Provincial law apply

This limited warranty gives you specific legal rights, and you may also have other rights which vary from jurisdiction to jurisdiction. The provisions of the United Nations Convention on Contracts for the Sale of Goods shall not apply to this limited warranty or the sale of products covered by this limited warranty.



Replacement Parts

| | |
|---------------------------------|--------------|
| Flicker Motor | 2000210300RP |
| Heater Assembly | 2203540100RP |
| On/Off Switch | 2800070200RP |
| Remote Receiver | 3000820100RP |
| Switch Board | 3000820300RP |
| Flicker Rod | 5902180100RP |
| Cordset | 4100190100RP |
| Capacitor | 2300030100RP |
| LED Driver Board | 3000810100RP |
| Remote Control | 3000370900RP |
| LED Light Strip | 3000830100RP |
| Bottom Glass Assembly | 690766XXXRP |

(For color specific part number contact Dimplex Technical Service)



Troubleshooting Guide

| Problem | Possible Cause | Corrective Action |
|---|---|--|
| Circuit breaker trips or fuse blows when unit is turned on. | Improper circuit current rating. | Additional appliances may exceed the current rating of the circuit breaker or fuse. Plug unit into another outlet or install on a dedicated 15-amp circuit. If problem persists, contact technical support. |
| Unit turns on or off by itself. | <ol style="list-style-type: none">1. Remote control has a similar frequency to another remote.2. Radio frequency disturbance from outside sources. | <ol style="list-style-type: none">1. Re-initialize remote or move unit out of range of interference.2. Change frequency of other device if possible.3. If problem persists, contact technical support. |
| Lights dim in room while the unit is on. | Unit is drawing close to circuit current rating. | Move the unit to another outlet or install unit on a dedicated 15-amp circuit. |
| Power cord gets warm. | <ol style="list-style-type: none">1. Normal operation.2. Improper extension cord in use. | <ol style="list-style-type: none">1. The power cord may get slightly warm to the touch when the heater is on.2. Ensure any extension cord used is rated for 1875 W and 14 AWG.3. If problem persists, contact technical support. |
| Fireplace does not turn on. | <ol style="list-style-type: none">1. Unit is not plugged in.2. Circuit breaker has tripped.3. Improper operation.4. Remote not initialized.5. Depleted batteries in remote. | <ol style="list-style-type: none">1. Plug unit in to outlet.2. Check electrical panel.3. Refer to instruction manual.4. Initialize the remote control.5. Install new battery into remote.6. If problem persists, contact technical support. |
| Flame frozen or shutters. | | Contact technical support. |
| Heater is not turning off. | <ol style="list-style-type: none">1. Improper operation. | <ol style="list-style-type: none">1. Refer to instruction manual.2. If problem persists, unplug unit and contact technical support. |



Troubleshooting Guide

| Problem | Possible Cause | Corrective Action |
|--|--|--|
| Heater is not turning on. | 1. Improper operation. | 1. Refer to instruction manual. 2. If problem persists, unplug unit and contact technical support. |
| Heater emits an odor. | 1. Normal operation. | 1. Normal operation is when the heater emits an odor for a brief period after the heater is initially turned on. The heater is burning off any dust accumulated during manufacturing or operation. 2. If problem persists, unplug unit and contact technical support. |
| Heater fan turns on but heater lacks heat. | 1. Improper operation. 2. Normal operation. | 1. Refer to instruction manual. 2. Normal operation. 3. If problem persists, unplug unit and contact technical support. |
| Heating element is glowing red. | 1. Normal operation. | 1. Small glowing sections of the element are considered normal. 2. If larger glowing sections are causing the heater to trip the thermal cutout, unplug unit, discontinue use and contact technical support. |



Dimplex North America Limited

1367 Industrial Road

Cambridge ON

Canada N1R 7G8

© 2011 Dimplex North America Limited